

# Amity

TECHNOLOGY



## OWNERS OPERATING MANUAL



## 2800 & 3350 AIR CART

S/N: 702045,702060...  
P/N 330538

Amity Technology, LLC  
2800 7th Avenue North  
Fargo, ND 58102  
(701) 232-4199  
[www.amitytech.com](http://www.amitytech.com)



## **AMITY TECHNOLOGY, LLC LIMITED WARRANTY FOR NEW PRODUCTS**

1. **General Provisions.** This Warranty shall apply to the original purchaser of (1) any new and unused machine manufactured by Amity Technology, LLC ("Amity"), and (2) any new and unused part which is manufactured by Amity for use in an Amity machine, jointly referred to as "Products," whether such Product is purchased through a dealer or directly from Amity. Under this Warranty, Amity will repair or replace, as it chooses in its sole discretion, any covered Product, or any component thereof, which Amity determines to be defective. This Warranty shall be in effect for a period of twelve (12) months ("the Warranty Period"), beginning on the date of delivery of the covered machine or part by the dealer or Amity to the purchaser ("the Warranty Start Date"). The purchaser must pay the cost of transportation of a Product to be repaired or replaced to and from an authorized Amity dealer. This Warranty may not be transferred from the original purchaser of a Product to any other person. This Warranty does not give a purchaser the right to any relief other than repair or replacement of the Product, and it specifically does not allow for consequential or incidental damages, exemplary or punitive damages, or costs and fees.
2. **Scope and Limitations of Warranty.** With respect to machines, this Warranty is void if any part not supplied by Amity is used in assembly or repair of the machine, or if the machine has been altered, abused or neglected, as determined by Amity. With respect to parts, this Warranty is void if the part is used in any manner other than that for which it is intended. This Warranty does not extend in any way to tires and any other component of a Product warranted by another manufacturer, a copy of which warranty is provided herewith ("Third-Party Warranties"). In the event Amity determines that a Product is not defective, or that any other provision of this Paragraph 2 operates to limit the Warranty, this Warranty shall not apply and the purchaser shall be responsible for transporting the Product from the authorized Amity dealer's location within 10 days of notice by Amity.
3. **Procedures for Obtaining Service.** To secure Warranty service, a purchaser must (1) report the defect to an authorized dealer and request repair within 45 days of the failure and within the Warranty Period; (2) present evidence that this Warranty applies to the Product; (3) present evidence of the Warranty Start Date; and (4) bring the Product to an authorized Amity dealer within a reasonable period of time after reporting the defect.
4. **LIMITATION OF IMPLIED WARRANTIES AND OTHER REMEDIES.** To the extent allowed by law, neither Amity, its dealers, nor any company affiliated with Amity makes any warranties, representations, or promises as to the quality, performance, or freedom from defect of any Product covered by this Warranty.  
**AMITY HEREBY WAIVES, TO THE EXTENT APPLICABLE, ANY AND ALL IMPLIED WARRANTIES OF MERCHANTABILITY AND FITNESS FOR A PARTICULAR PURPOSE. A PURCHASER'S ONLY REMEDIES IN CONNECTION WITH THIS WARRANTY ARE THOSE SET FORTH ON THIS PAGE. IN NO EVENT WILL AMITY, ITS DEALERS, OR ANY COMPANY AFFILIATED WITH AMITY BE LIABLE FOR INCIDENTAL, CONSEQUENTIAL OR PUNITIVE DAMAGES.**  
Some states do not allow waivers of certain warranties, so the above waivers may not apply to you. You may also have other rights which vary from state to state.
5. **No Dealer Warranty.** This is the exclusive warranty applicable to Amity Products. No dealer has any authority to make any other warranty, modify, limit, or expand the terms of this Warranty in any fashion, or make any representation or promise on behalf of Amity.
6. **Dispute Resolution.** Any controversy or claim arising out of or relating to this Warranty must be settled by arbitration in Fargo, North Dakota, at a time and location designated by the arbitrator, but not exceeding 30 days after a demand for arbitration has been made, and may be conducted by electronic, video, or other technical means. Arbitration will be conducted by the American Arbitration Association in accordance with its Rules of Commercial Arbitration, and judgment upon the award rendered by the arbitrator may be entered in any court having jurisdiction thereof. The arbitrator will have the authority to order Amity to undertake a repair or replace any Product, at its election, if the arbitrator finds that this Warranty requires Amity to do so. The arbitrator will not have the authority to impose any other remedy against Amity, including without limitation consequential or incidental damages, exemplary or punitive damages, or costs and fees.

• AMITY TECHNOLOGY, LLC • 2800 7TH AVENUE NORTH • FARGO, ND 58102 • e-mail address: [info@amitytech.com](mailto:info@amitytech.com) •  
**(701) 232-4199      fax (701) 234-1716**

Prices subject to change without notice

## TABLE OF CONTENTS

---

Precautions.....	6
Safety First	
Features and Specifications.....	7
Air Cart	
Conversion Factors	
Formulas	
Mechanical Systems - Setup and Operation.....	8
Safety Railing / Ladder	
Product Bin Lids	
Auger	
Ground Drive	
Hydraulic Systems	
Hydraulic Drive	
Blower	
Tires and Rims	
D3 System Overview.....	15
D3 System Hardware	
Cart Control General Information.....	17
System Set Up.....	24
Dry Product/Bin Settings.....	28
System Settings Screen	
Bin Size (Volume)	
Bin Count %	
Product Weight/Volume (Density or Test Weight)	
Product Weight; Adjusting Product Meters	
Ground Drive (GD) Calibration and Operation	
Hydraulic Drive Calibration and Operation	
Mechanical Systems - Maintenance and Troubleshooting.....	42
Routine Maintenance	
Changing Metering Rolls - Ground Drive System	
Changing Metering Rolls - Hydraulic System	
Meter Roll Options	
Other Meter Adjustments	
Gear Box	
Mechanical Systems Troubleshooting: Common Problems and Solutions	

<b>Storage</b>	
<b>Appendix: Connector Pinouts.....</b>	<b>50</b>
<b>ECU Signal Conectors</b>	
<b>ISO-BUS Connector</b>	
<b>CAN Terminator Connector</b>	
<b>ECU Power Contacts</b>	
<b>Motor Control Connectors</b>	
<b>Low-Bin Level Sensor Connectors</b>	
<b>Motor Speed (Tach) Connectors</b>	
<b>Meter Box Sensor Connectors</b>	
<b>Ground Speed Sensor Connectors</b>	
<b>Fan Sensor Connectors</b>	
<b>Anhydrous Ammonia/Liquid Control Connector</b>	
<b>Approximate Tank Fill Percentages</b>	
<b>Advanced Screens</b>	
<b>Sensor Types</b>	

## Congratulations!

Congratulations on your purchase of an Amity Technology Air Cart! Your Model 2800 or 3350 Air Cart has been designed to be durable, versatile, and simple to use.

Your Air Cart features stainless steel tanks and metering components, a streamlined and reliable meter system, a fill/unload auger with cupped poly flighting, and a world class ISOBUS-compatible monitoring and control system.

The following pages contain a wealth of important information on your Air Cart's features, equipment and systems. Read this manual carefully to learn how to set up, operate and use this equipment.

## PRECAUTIONS

---

### Safety First

---

The purpose of this manual is to assist you in safely operating and maintaining your Amity Technology equipment. It is the responsibility of the owner to ensure that anyone operating this equipment thoroughly reads and understands the information in this document.

It is not possible to overstate the importance of safety. Serious injury or death can result from improper operation of any farm equipment. We have taken great care to point out potential hazards that require special consideration.

#### **Warning and Caution Symbols**



*This manual uses the following symbols to signify caution and warning. For your own safety take note of these symbols and exercise caution when working with this equipment.*



#### **Warnings**

***ALWAYS** know your equipment. Read the owners manual before operating.*

***DO NOT** allow anyone to ride on the air system.*

***ALWAYS** install and transport stops when transporting the drill.*

***ALWAYS** use an adequate tow vehicle.*



***ALWAYS** remember to properly secure the safety chain.*

***DO NOT** Transport at speed greater than 20 MPH (32 KmPH).*

***DO NOT** modify or alter this equipment without first contacting Amity Technology, LLC.*

#### **Caution**

***ALWAYS** keep decals free of dirt and replace if they become damaged. See the parts section for proper placement.*



***ALWAYS** avoid high-pressure fluids. Use a piece of cardboard to search for suspected hydraulic leaks.*

## FEATURES AND SPECIFICATIONS

### Air Cart

Feature	AS2800	AS3350
Hopper Capacity	280 Bu (168 rear, 112 front)	335 bu (200 rear, 135 front)
Blower Drive	Hydraulic	Hydraulic
Meter Drive	Ground (optional Hydraulic)	Ground (optional Hydraulic)
Wheel Spacing	120" (36.6 m) front 150" (45.7 m) rear (120" rear optional)	120" (36.6 m) front 150" (45.7 m) rear (120" rear optional)
Tire Size	23.1 x 26 R1 - Standard (58.7 cm x 60 cm) 18.4 x 26 - Optional (46.7 cm x 60 cm)	23.1 x 26 R1 - Standard (58.7 cm x 60 cm) 18.4 x 26 - Optional (46.7 cm x 60 cm)
Fill/Unload Auger Cupped steel flighting (poly flighting optional)	10" x 21' (25.4 cm x 6.40 m)	10" x 21' (25.4 cm x 6.40 m)
Total height	12' 7" (3.84 m)	13' 5" (4.09 m)
Total length	27' (8.23 m)	27' (8.23 m)
Max width	14' 5" (4.39 m)	14' 5" (4.39 m)
Fill height	11' (3.35 m)	11' 10" (3.60 m)
Minimum ground clearance	19" (48.3 cm)	19" (48.3 cm)
Empty weight	8400 lbs (3810 kg)	8600 lbs (3900 kg)

### Conversion Factors

1 Hectare = 2.47 Acres	1 lb = 0.45359 kg	1 bushel = 1.2445 cubic ft
1 acre = 43,560 square feet	1 lb = 16 oz	1 bushel = 0.0352 cubic meters
1 acre = .404 Hectares	1 kg = 35.3 oz	1 bushel = 9.31 gallons
1 inch = 2.54 cm	1 oz = 0.028 kg	1 PSI = 6.8948 kPa
1 foot = 0.3048 m	1 mph = 1.609 kph	1 GPM = 3.785 LPM
	1 mile = 1.609347 km	

### Formulas

$$\text{Rate (lbs/min)} = \frac{\text{Width (ft)} * \text{Speed (mph)} * \text{Field Rate (lbs/acre)}}{495}$$

$$\text{Performance (acres/hr)} = \frac{\text{Width (ft)} * \text{Speed (mph)}}{8.25}$$

# MECHANICAL SYSTEMS - SETUP AND OPERATION

## Safety Railing / Ladder

Your Air Cart is equipped with a ladder and safety railings for access to the top of the tanks. Always make sure that the safety railings are secured in the raised position when operating the air system. The railings may be lowered for storage if required.

To lower the railings, remove the top bolt from each of the legs on the railing sections. Rotate the railing section down so that they hang beside the air system and reinsert the bolts in the holes for storage.



### Caution

*Do not lower the railings while standing on the catwalks. Use a suitable ladder and lower them from below. Always have the railings raised when working on top of the air system.*



*Safety railings*

## Product Bin Lids

The compartment lids on the air system compartments must be properly closed and sealed for the meters to deliver product properly.

Periodically check the lid for proper adjustment and inspect the seal for damage.

**To determine whether the lid is adjusted properly**, observe the lid when it is unlatched. It should incline slightly toward the latch end. A firm pull on the latch handle should be required to over-center the latch.

**To adjust the hinge end of the lid**, loosen or tighten the jam nuts on the hold down bar. (See photo)

**To adjust the latch**, loosen or tighten the nuts on the toggle u-bolt. (See photo)

In the off season, it is recommended that the latch be released to relieve pressure on the gasket.



### Caution

*If equipped with screen baskets, do not step or lean on the screens. They will not support a person's weight and may fall into the tank, resulting in injury.*



*Lid and latch with toggle u-bolt adjustment*



*Jam nuts on hold-down bar*



## Auger

Your Air Cart is equipped with an auger for loading and unloading the product bins. The auger is mounted on a swing arm that allows a flexible discharge hose to be moved to each compartment without moving the hopper. The swing arm also enables the auger to be turned around to unload and clean out the compartments.

The auger's hydraulic drive is supplied with oil from the blower hydraulics. A diverter valve above the blower directs oil to the auger. This may be switched with the blower running.

The auger also has a three position variable speed valve mounted on it to run the auger forward, backward or to stop.



*Air cart with auger*

### *Using the Auger to Load Products*

The auger can be used to load and unload seed tanks. It can be adjusted on brackets to suit the operator's needs.

#### **To place the auger in operating position:**

1. Drop the front bracket lock pin just far enough to release the small pivot arm. (Unpin the long arm only to unload.)
2. Loosen the lock assembly. (Tee Handle)
3. Remove the auger from the rear clamp assembly.
4. Swing the hopper end of the auger away from the Air System and allow the short pivot arm to come out, away from the machine.
5. Place the hopper on the ground in a position perpendicular to the center line of the tanks with the discharge end of the auger between the compartment lids. From this position the discharge end of the auger should be able to be moved between compartments without moving the hopper.

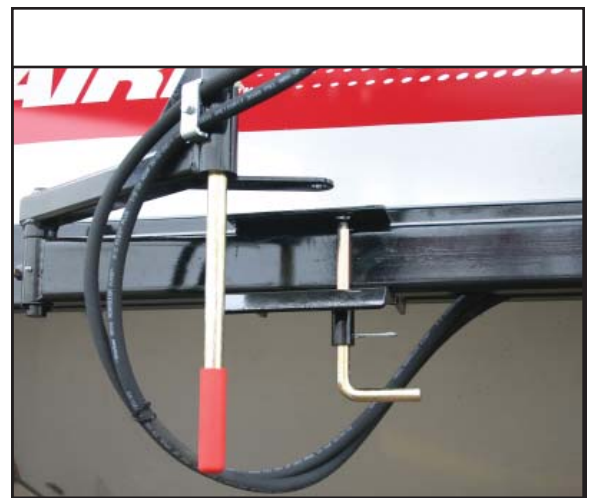

*Swing arm, bracket lock pin and small pivot arm*



*Air cart with auger in loading position*

## *Using the Auger to Unload Products*

---

1. Swing the large arm far enough away from the machine to allow the hopper to fit between the wheels.
2. Place the hopper under the meter for the compartment you wish to empty.



*Placing the hopper under the meter*

3. Close the metering slide.
4. Remove the product meter door.
5. Open the metering slide to control flow from the compartment.

---

### *Note*

*Removing the pointer allows the gate to be opened without changing the rate setting.*



*The meter with door removed*

## *Cleaning Out the Auger*

---

1. Tip the hopper upside down to empty.
2. Run the auger backwards until the auger tube is empty.



*Hopper in the upright position*

## Ground Drive

On air carts equipped with ground drives a magnetic clutch allows the drive to be disengaged. The magnetic clutch uses electrical power to hold it engaged. The clutch is turned on and off by the D3 System either automatically when the drill is raised and lowered, or manually by pressing a manual Master Work Switch soft key on the virtual terminal in the tractor cab. The clutch requires no service.

When transporting long distances, remove the drive chain at the drive wheel. This will extend chain and sprocket life.

---

### *Note*

*Maximum recommended transport speed is 20 mph*



*Magnetic clutch*

## Hydraulic Systems

The hydraulic system on 2800/3350 air systems consists of a blower control circuit, an auger control circuit, and an optional Hydraulic drive control circuit. A combination of various control valves enables all three circuits to be powered by one hydraulic remote on the tractor. This system was designed to function under a maximum hydraulic pressure of 2900 psi.

---

### *Hydraulic Capacity*

*To run the hydraulic blower at the appropriate blower rpm., the tractor must have the following hydraulic capacities:*

<b>Blower RPM</b>	<b>Hydraulic Requirements (Ground Drive)</b>	<b>Hydraulic Requirements (Hydraulic drive)</b>
5000	13 GPM at 1500 to 2200 PSI	18 GPM at 1500 to 2200 PSI
6000	16 GPM at 1700 to 2450 PSI	21 GPM at 1700 to 2450 PSI

---

### *Air System to Drill Hydraulic Couplers*

The couplers connecting the air system to the drill/implement are 3/4 inch, high-flow couplers. Using 3/4 inch couplers reduces the pressure drop across the coupler and enables the operator to easily disconnect the air system from the drill.

The blower motor case drain line employs a 1/2 inch coupler. This smaller size ensures that it cannot be confused with the larger 3/4 inch couplers.

It is important to ensure that the pressure line on the tank is connected to the pressure line on the drill.



*Hydraulic Couplers*



## *Tractor to Blower Hydraulic Couplers*

One-half (1/2) inch Pioneer tip couplers connect the blower pressure and return lines to the tractor.

A 3/8 inch flat-face coupler tip on the drill connects the case drain line to the tractor. This line must be connected or the blower motor will be damaged. If a case drain return port is not available on your tractor, contact your dealer for assistance in determining how to connect this line to the tractor's hydraulic reservoir.

A 3/4 inch low-pressure return tip is included with all Amity implements. It is also available through Amity Service Parts. If your tractor has a low-pressure port available, this tip can be used on the 3/4 inch blower return line to eliminate the pressure drop caused by the 1/2 inch Pioneer tip and the tractor's hydraulic valve on the return side. This tip can also be used on the case drain line, if the 3/8 inch flat face port is not available and the 3/4 inch low pressure return port is.

Do not install a tee connecting the blower return line and the blower case lines together. The blower case line must always be connected to a direct return to the hydraulic reservoir or blower motor failure will result.

The hydraulic line marked *Pressure* must be used to operate the blower. A check valve is installed in the blower circuit to protect the motor from an accidental pressurization of the return line.

---

### *Note*

*The 3/4 inch low pressure return tip is not compatible with the 3/4 inch high flow fittings used at the front of the cart. They look similar, but they are not compatible.*



*Tractor Hydraulic Connections (1)*



*Tractor Hydraulic Connections (2)*

## **Hydraulic Drive**

Air systems equipped with the hydraulic option use electric-over-hydraulic (EOH) technology to control the meter speed independently of ground speed. This gives the operator the benefit of a faster calibration procedure and on-the-go rate changing capability as well as the potential to apply product to a prescription map using GPS.

The hydraulic control valve diverts 5 GPM of hydraulic fluid flow from the fan circuit to power the variable rate drive motors. An electro-proportional flow-control valve controls the speed of each motor, allowing the meters to turn at speeds completely independent of each other.



*Hydraulic Control Valve*

The hydraulic drive motors mount to the meter housing and provide a direct drive of the meter shaft. The motor has a built-in speed sensor to provide accurate meter speed feedback to the electronics system.



Hydraulic Drive Motor

## Blower

The air cart's blower system generates air pressure/flow to carry the seed or other input products through the system to the implement. The blower is driven by a hydraulic motor.

Two 3/4" hydraulic lines supply oil to the blower. A check valve is used on the return line to protect the system from running backwards. The hydraulic motor on the blower also has an internal check valve to prevent motor cavitation during shut down.

A third smaller (1/2") line connected to the blower motor is a case drain line. It is imperative that this is connected to a line directly to the tractor reservoir. Back pressure on this line will cause the shaft seal on the motor to fail. It is recommended that a female connector is used on this line at the tractor connection so that this line cannot accidentally be connected to pressure.

The only serviceable part on the blower is the shaft seal. This may be replaced if the motor leaks at the shaft. Do not disassemble the motor to replace the shaft seal. It is secured by a snap ring and can be removed with a seal pick.

A diverter valve above the blower selects either the fan or auxiliary (auger and/or winch) function. Push the knob in to run the blower. Pull the knob out to run the auger or winch.



The blower and associated hydraulics



### Caution

*Be sure that the case drain line on the blower motor is not connected to pressure. Damage to the shaft seal or motor will result.*



### Warning

*Do not under any circumstances disassemble the motor. It is very difficult to assemble correctly and motor destruction will result from running an incorrectly assembled motor.*

---

### Note

*Switch off fan to switch to auger.*

## Setting Blower Speed

The blower should be operated at as slow a speed as possible to prevent damage to seed. If operated too slowly, line blockage will occur. Typical blower speeds are between 3800 and 6000 RPM. Drill width, product, rate, humidity and other factors affect blower speed.

If you do not have a run blockage monitor, carefully watch to see that all runs are operating after changing blower speeds. To check runs, turn meter(s) with blower running and look to see that there is product at each ground opener.



### Note

The number of outlets on the drill will directly affect the blower rpm. The more outlets in use, the higher the pressure required to maintain blower rpm. See your dealer for hydraulic adjustments to your tractor, if necessary.

### Note

A diverter valve (2) above the blower selects fan or auxiliary (auger and/or winch) function. Push the knob in to run the auger or winch. Pull the knob out to run the blower.



### Warning

Do not under any circumstances disassemble the motor. It is very difficult to assemble correctly and motor destruction will result from running an incorrectly assembled motor.

## Tires and Rims

Inflate tires to the pressure indicated in the adjacent table. Torque lug nuts to 240 ft/lbs and retighten after the first 10 hours of operation.



### Caution!

Maximum speed of the air system is 20 mph.



## CAUTION!



### TIRE PRESSURES

Tire Size	Tire Ply	Tire Pressure
18.4 X 26.0	10	26 (MAX)
23.1 X 26.0	10	20 (MAX)



## D3 SYSTEM OVERVIEW

---

Your Air Cart utilizes a state-of-the-art electronic system to monitor and control the air cart's functions. The D3 ISO Monitor system is based on the ISO 11783 standard, often also referred to as ISOBUS. ISOBUS is a communications standard that enables a variety of agricultural electronics systems to talk to each other. Its purpose is to integrate all current and future farm functions by standardizing communication between tractor and implement. ISOBUS permits the use of the same tractor terminal on a number of different machines and hence control of a wide range of implements without the need to reprogram a system.

### D3 System Hardware

---

The D3 ISO System includes a D3 electronic control unit (ECU), which connects to a variety of sensors and an electric-over-hydraulic (EOH) meter drive system. The ECU communicates with a virtual terminal (VT) located inside the tractor cab. The VT displays information and enables you to configure, calibrate and operate multiple systems from a single user interface.

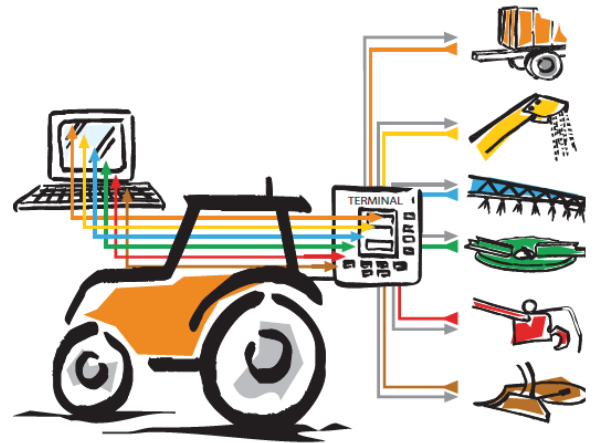

### D3 Electronic Control Unit

---

The ECU is mounted on the air system. It monitors all system sensors and controls the meter drives. The ECU connects to the VT in the tractor cab via an interconnecting cable that plugs into the front of the ECU on one end and into the standard ISOBUS connector on the tractor at the other end.



*D3 ECU*

### Virtual Terminal

---

The VT in the tractor cab provides a user interface for the system, communicating with the D3 ECU and (any other ISOBUS-compatible equipment you may add to your equipment). Your VT could be the Amity-supplied VT, the tractor's OEM VT, or any other ISOBUS-compatible VT.

Several companies manufacture ISOBUS-compatible virtual terminals. All terminals use the same screen icons to represent the main functions. The control screens, or pages, for the implement (which are displayed in the central area of the screen) are identical for any ISOBUS-compatible terminal.

Currently the following virtual terminals can be used with your ISO Drill Manager system:

- GTA Console 1 and Console 2 (AGCO)
- AFS Pro 600 & Pro 700 (Case IH)
- GreenStar2 & GreenStar3 (John Deere)
- IntelliView II IntelliView Plus II (New Holland)
- IntelliAg (DICKEY-john)
- LH6000 (TeeJet)



*C1000*

### ***Blower Speed Sensor***

An inductive sensor on the blower fan provides speed information to the ECU.



### ***Bin Level Sensor***

Optical bin sensors indicate when the level of product in the bin has decreased to the level of the sensor. The same sensor detects all types of products. The sensor height can be adjusted vertically to set the alarm point at any desired level.



### ***Meter Box Flow Sensor***

A capacitive sensor detects when the meter box is empty. This indicates if the bin is completely empty, or if the product has stopped flowing into the meter box because of bridging or a leaky lid on the bin.



### ***Meter Shaft Speed Sensor (Ground Drive)***

A magnetic proximity sensor is used to detect the speed of the meter shaft. This information is used to calculate how much product has been applied and also indicate that the ground drive system is function properly.



### ***Meter Shaft Speed Sensor (Variable Rate)***

If the air system was purchased with the variable rate option, an integral speed sensor is provided with the hydraulic motor. This sensor is very accurate and provides the precise meter speed control that is needed.



### ***Ground Speed Sensor***

This unit is equipped with a GPS speed sensor. This is used for speed sensing only and cannot be used for mapping.





# CART CONTROL GENERAL INFORMATION

## Using Virtual Terminals with Your Cart Control System

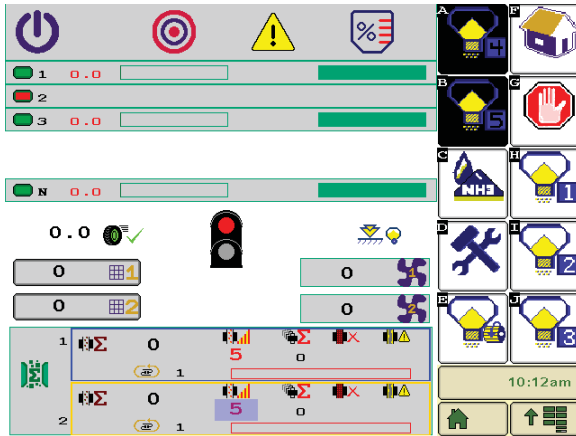

An example of an ISO Monitor page

Any ISOBUS-compatible virtual terminal (VT) should be able to communicate with and control your Cart Control System. When the VT in your tractor is connected to the ECU on the cart it downloads the information from the ECU and displays it on the VT's screen. The central part of the screen displays information pages identically, regardless of the VT you are using. Typically, icons representing other pages are located around, or to the side of the central part of the screen. Selecting these soft keys enables you to navigate to the pages they represent. The location of page icons may vary depending on the manufacturer of the VT. Also, some VTs have touch screens, whereas others use pushbuttons located around the outside of the screen, adjacent to on-screen icons.

ISOBUS compatible VTs can be used to set up, operate and monitor your Cart Control System but the exact details of how to access and change values and settings may vary from manufacturer to manufacturer. You will have to consult the manufacturer's operating manual for your specific VT to determine the details.

### **Tip!**







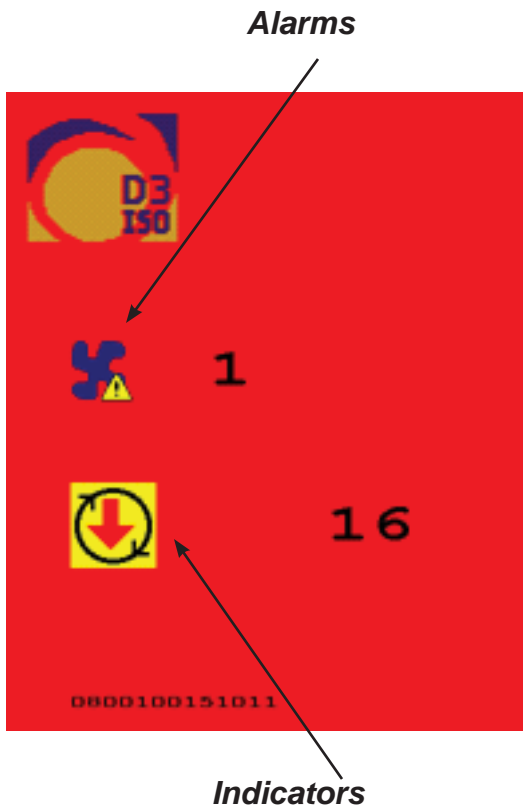

For detailed information on how to operate your virtual terminal, refer to its operation manual.

# Alarm and Indicator Icons

The following is a list of alarms and Indicator that could occur during system operation. Alarms show up as separate screens and are acknowledged based on your Virtual Terminal type.



Icon	Alarm
	Product Rate Alarms
	Bin Alarms
	Fan Alarms
	Meter Box Alarms
	NH3 Alarms
	Blockage Alarms
	Low Ground Speed Alarm
	Battery Voltage Alarm
	Internal Alarm
Icon	Indicator
	High RPM Indicator
	Low RPM Indicator
	Empty Indicator

Icon	Indicator
	High Voltage Indicator
	Low Voltage Indicator
	Current Overload Indicator
	No Tachometer Indicator
	SPI Communication Failure Indicator
	Low Seed Rate Indicator
	Blocked Seed Run Indicator
	Loop Communications Failure Indicator

**Low RPM Indicator**

**Note:**

- This alarm screen shows Fan 1 in alarm with a RPM of 16.

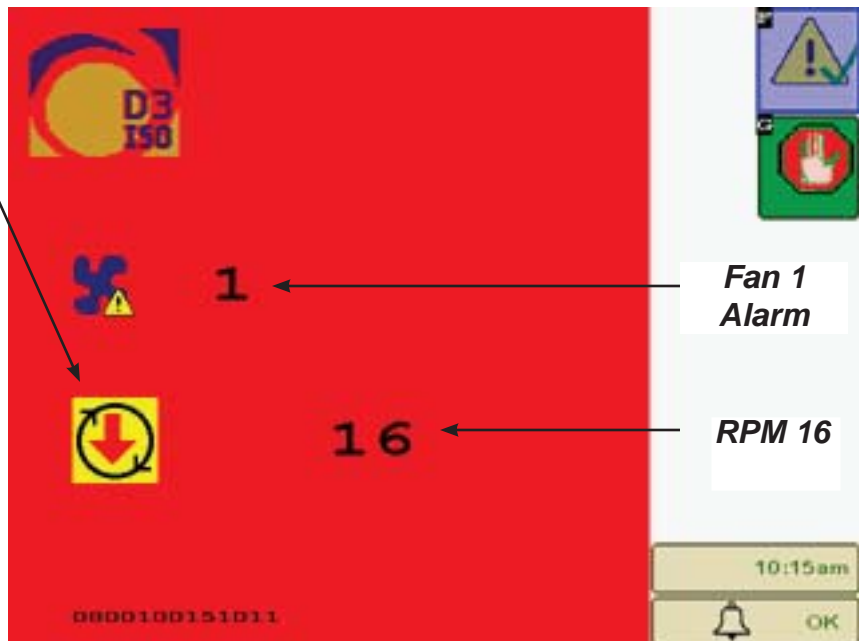

- Acknowledging the alarm is done by either touching the "OK" softkey or the "ESC" button. This will vary based on which virtual terminal you are using.



## Confirmation Screen

---

Changing of certain settings or values on your Amity Cart Control System may require confirmation, clearing an acre counter for example. When confirmation is needed, a confirmation screen will appear.

- To Confirm your selection and return to the previous screen, select the  softkey.
- To Cancel your selection and return to the previous screen, select the  softkey.

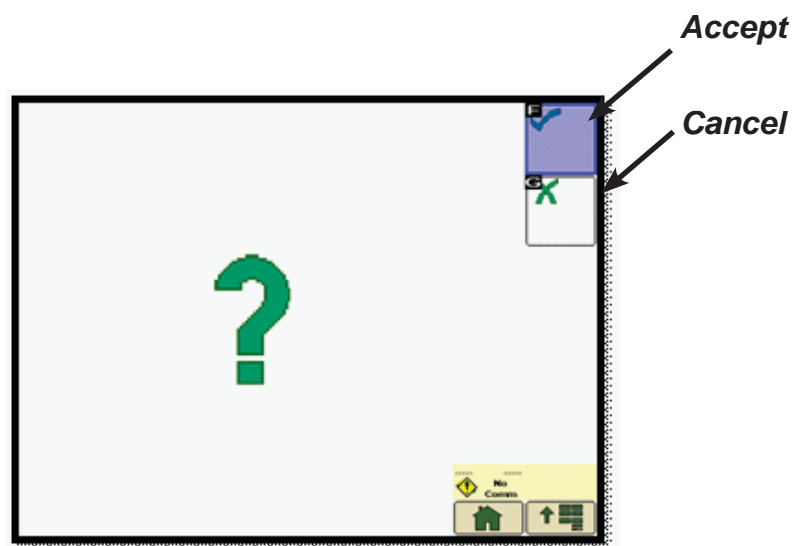

# Main (Home) Screen

On the Main page of the Cart Control System you can view many critical machine functions. The following screen shot shows the key information provided on this page. Each function will be explained in greater detail following this diagram.

## Seeder up/down

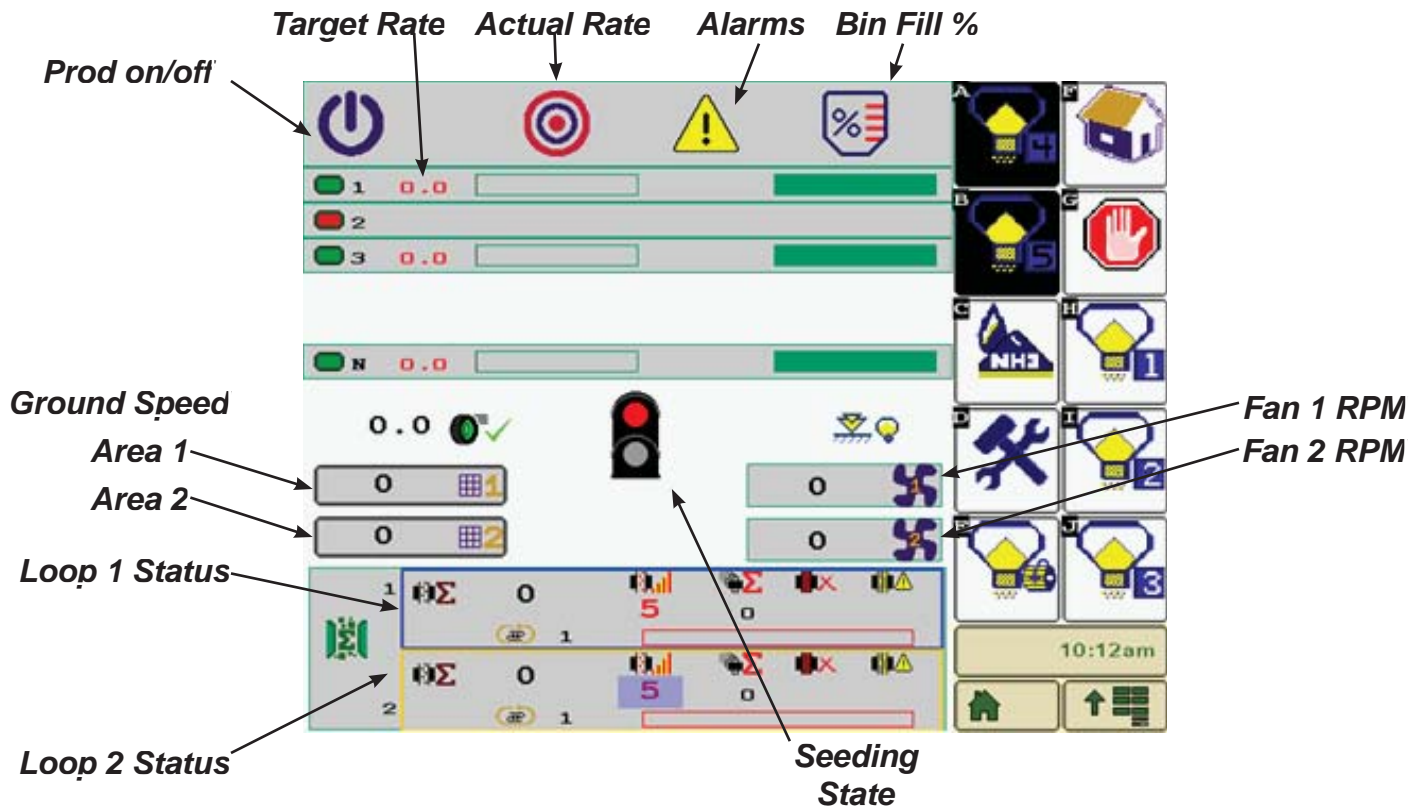

Home Screen Softkeys			
Icon	Page	Icon	Page
	Main (Home)		On/Off (Manual Work Switch)
	System Settings		Product Bins Settings (1-5)
	NH3 Settings		Meter Fill

**Note:** If the softkey is blacked out, it means either the feature is turned off or the feature is setup to be used with an External ECU (Blockage or NH3 for example).

## Fan RPM

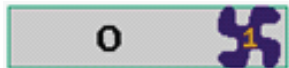

Displays Fan speed in RPM. Min and Max alarms can be set in the **System Settings** screen. See System Setup for more information.

## Product On/Off



Pressing the **Product On/Off** buttons will turn any particular product on or off. A **Green** indicator represents **Product On** and a **Red** indicator represents **Product Off**.

The single clutch on Ground Drive units is tied to Product 1, individual bin control is not available.

## Desired Rate



The Desired rate for each product is entered by modifying the **Red** value next to Product On/Off. Desired Rate displays lb/acre (kg/ha).

Note: Desired Rate is for reference only on ground drive units.

## Actual (Live) Rate



Graphically displays the Actual Rate for Motors 1-5 and N (liquid NH3) as a percentage (0-200% of desired rate). When the indicator bar is in the center of the graph, the Actual Rate matches the Desired Rate. The Desired rate for each product is also numerically shown in **red**.

## Product/Bin Alarms



The following symbols can be displayed in the alarm box for each product/bin.

Symbol	Alarm
	Bin Low Alarm
	Meter Box Low Alarm
	Drive Manual Mode
	Rate High Alarm
	Rate Low Alarm
	Motor Overload Alarm
	No Tachometer Alarm
	No Slave ECU
	Calibration Active

## Bin Count



Displays the status of the bin levels as a percentage. The Bin Count feature can be calibrated in the **Product Calibration** screen. These indicators are an approximation based on the calculated meter accumulation and must be properly calibrated in order to properly function.

## Ground Speed



Displays Fan speed in RPM. Min and Max alarms can be set in the **System Settings** screen. See System Setup for more information.

## Area Counters



Displays total area in **Acres** or **Hectares**. Pressing the **Area** button will clear the area accumulation.

## Seeder UP/Down



Displays the current up or down state of the seeder. If there is a work switch on the seeder, the **Seeder Up/Down** indicator will change as the seeder is lifted up or set down. If there is no work switch present on the seeder, the **Seeder Up/Down** indicator will always reflect the down position.

## Seeding State



Displays whether the seeder is seeding or not. A **green** indicator will show when the drill is in the seeding state. Seeding can only occur if the **Seeder Up/Down** indicator is in the down position, the work switch softkey is **green**, and speed is present.

## Work Switch Softkey



Pressing the **Work Switch Softkey** will turn the seeder on if there is no automatic work switch installed on the seeder. If there is an automatic work switch installed on the seeder, pressing the **Work Switch Softkey** will enable operation of the automatic work switch.

# SYSTEM SET UP

## Important!

This system setup procedure **MUST** be completed or your system will not operate correctly. Complete all steps.

Before operation of your new Amity Cart Control System, there are a few simple setup and calibration procedures that must be performed to ensure proper seeding performance. If these operations are not completed, seeding performance and accuracy will be affected.

## System Settings Screen

Use the following procedures to set up system parameters before using your system:

The screenshot shows the following settings and controls:

- Cart Model:** 280, 335, 380, 525
- Drive Type:** [Icons for different drive configurations]
- Fan Enable:** [Icons for fan configurations]
- NH3 Enable:** [Power icon]
- Implement Width:** 480, 394
- External ECU Setting:** [Icons for TCRN ART, TCRN NH3, and a green checkmark]
- Software Version:** v03.0z
- Ground Speed Type:** [Progress bar]
- Units Indicator:** U - U.S., M - Metric, I - Imperial, ? - Mixed
- Fan Settings:** [Icons for fan speed and sensor channels]

System Setup Screen Softkeys			
Icon	Page	Icon	Page
	Main (Home)		On/Off (manual work switch)
	Advanced Settings		Sensor Channels
	Advanced Settings Lock		



## Units



The Amity Cart Control System utilizes either SAE (US) or Metric units. Units are configured in the Virtual Terminal System Settings. Verify which system of units your VT is using before entering these values and operating your system. Refer to your VT Operators Manual for more information on checking the units. The **Units Indicator** on the **System Setup Screen** displays the units setting of the Virtual Terminal for your reference.

## Cart Model



The Cart Model is a preset factory selection. It sets all necessary advanced settings for the defined cart.

## Drive Type



The Drive Type is a preset factory selection. It sets all necessary advanced settings for the defined drive type. The first selection is for ground drive, the second is for hydraulic drive.

## Fan Enable



Fan Enable selection is defined by the user. Selection is either **Green On** or **Gray Off**. Fan Enable allows for the display of fan rpm and fan alarms.

## NH3 Enable



NH3 Enable selection is defined by the user. Selection is either **Green On** or **Gray Off**. NH3 Enable allows for NH3 application.

## Implement Width

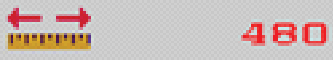

### Tip!

If your machine is 60 feet wide, multiply 60 X 12 inches per foot = 720 inches. Enter "720".

Step 1. On the System Setup page, select **Width** by pressing the number next to the width icon.

Step 2. Enter the width value in **inches** or **millimeters**.

## Ground Speed Type



Pressing the Speed Button will toggle between the different ground speed input types. The ISO speeds are only available if the tractor is broadcasting these over the ISO-BUS.

Symbol	Speed Type
	Cart Speed (Default for Normal Operation)
	Test Speed (Set in the Calibration Menu)
	ISO Ground Speed (Tractor GPS)
	ISO Wheel Speed (Tractor Wheel or Radar)

## Test Speed



### Note:

Speed Type must be set to Test Speed to take effect

Step 1. Select the number next to the **Test Speed icon**

Step 2. Enter the desired test speed in **mph** or **kph**.

A test speed will affect both dry products and NH3 operation.

## Fan Targets and High/Low Alarms

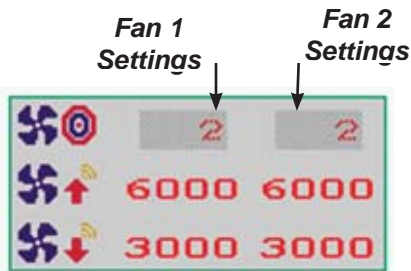

Fan target settings as well as fan high and low alarm settings are shown here. The fan high and low alarm values are editable and can be changed based on user preference.

## Work Switch Operation



The Cart Control System is equipped with manual and automatic work switches. The manual work switch is a soft key, located on most screens. The automatic work switch is a sensor, located on toolbar. When the system is configured for automatic work switch operation, lifting the machine automatically turns off the meters and NH3 system. Lowering the machine automatically turns on the meters and NH3 system. In this mode you can also use the manual work switch soft key on the main (Home) screen to turn the meters and NH3 system off. If you prefer to operate the meters and NH3 system in manual only, you can configure the system to disable the automatic work switch.

## Setting Up Work Switch Operation

Selection of manual or automatic work switch is located on the Toolbar ECU Main (Home) page.  Select the work switch button to switch between work switch modes.

Green indicates Automatic Work Switch mode



Gray indicates Manual Work Switch mode (Automatic mode off)



## Manual Work Switch Operation

The On/Off (Work switch) soft key  turns products on or off.

## Automatic Work Switch Operation

### *Note:*

*The following conditions must be met for the clutch to engage or for the hydraulic motors to turn:*

*-Ground Speed must be above the minimum speed setting.*

*-The Work Switch Softkey must be green*

*-The Seeder Up/Down must show "Seeder Down".*

### *Tip!*

*You can still use the On/Off (Work switch) soft key on the main (Home) page to turn the machine off in automatic mode.*

Use the following procedure to set up **Automatic** Work Switch operation:

Step 1. Raise the seeding system.

Step 2. On the Main (Home) page, press the On/Off (Work switch) soft key. 

Step 3. Start moving forward in the field with the tractor and planting system.

Step 4. Lower the seeding system. The **Seeder Up/Down** display should indicate **Down**.



The Seeding State display should turn green. 

# DRY PRODUCT/BIN SETTINGS



Each product has its own screen to set up and monitor application rates.

•Numbers in **RED** are input numbers that can be modified.

•Numbers in **BLACK** are displayed output numbers that cannot be modified.

The screenshot shows the 'Dry Product/Bin Settings' screen. At the top, it displays '1'. Below this are three main sections:

- Bin Settings:** A box containing a calculation:  $100\% \times 175 \times 60.01 = 10501$ . The numbers 100%, 175, 60.01, and 10501 are in red.
- Calibration Settings:** A box containing two calculations:  $\Sigma \text{ (bin icon) } 0.00 = \text{ (bin icon) } 1.04$  and  $\Sigma \text{ (bin icon) } 0.0 = \text{ (bin icon) } 62.1$ . The numbers 0.00, 1.04, 0.0, and 62.1 are in red.
- Buttons:** Below the calculations are several buttons:
  - A button with a power icon and a bin icon.
  - A button with a bin icon.
  - A button with a power icon and a bin icon.
  - A button with a power icon.
  - A button with a bin icon.
  - A button with a power icon and a bin icon.

On the right side, there are three large icons labeled F, G, and H:

- F:** A house icon.
- G:** A red octagonal stop sign with a hand icon.
- H:** A power icon with a checkmark.

At the bottom right, there is a digital clock showing '10:13am' and two buttons: a home button and a list button.

Labels with arrows point to various elements:

- Bin Settings:** Points to the top calculation box.
- Calibration Settings:** Points to the middle calculation box.
- Button Clears area:** Points to the buttons below the calibration settings.
- Amps:** Points to the bottom-most button.
- Product On/Off Must be 'On' for Calibration:** Points to the power icon button.
- Task Controller Seed/Fertilizer:** Points to the bin icon button.
- Task Controller On/Off:** Points to the power icon button.
- Button Clears Accumulation:** Points to the power icon button.

Dry Product Screen Softkeys			
Icon	Page	Icon	Page
	Main (Home)		On/Off (Manual Work Switch)
	Product On/Off		

## System Settings Screen

---

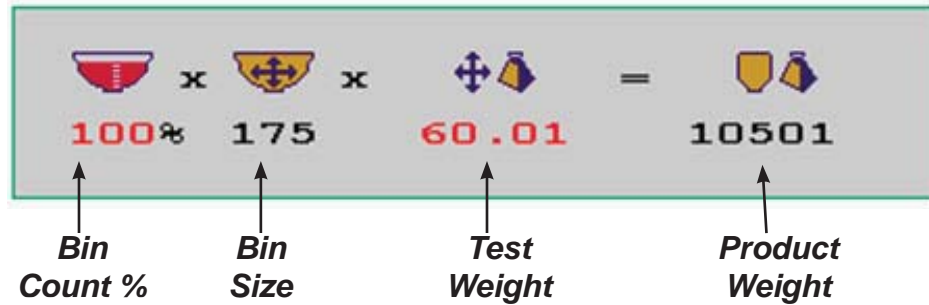

### Bin Size (Volume)

Bin Size displays the size of the tank in **bushels (liters)**. This value is pre-set at the factory and is used for the Bin Count and Product Weight features.

### Bin Count %

Enter the percentage of estimated product in the bin each time the tank is filled. When calibrated properly, the Bin Count feature provides an estimated approximation of the product left in that bin. This percentage is displayed on the status bar on the Home Screen.

### Product Weight/Volume (Density or Test Weight)

Enter the test weight of your product in **Pounds/bushel (Kg/liter)**. This value is needed for proper operation of the "Bin Count" feature.

### Product Weight

Displays estimated remaining product weight in the bin in **Pounds (Kg)**.

## Adjusting Product Meters

The product meters deliver seed or fertilizer from the product bins to the air stream via a fluted roller. The amount of the roller that is being used determines the rate at which products are applied.

There are two moveable components in the meter that determine the rate setting.

The primary setting is a flow plate adjusted by a rod connected to a pointer. When a rate setting is selected, the pointer is simply placed at that number on the rate decal. A lock bolt on the pointer rod secures the setting.

The second part of the adjustment is the meter shut off slide. For any rate setting the proper place for shut off slide is against the stop on the pointer. This opens the bottom of the tank compartment the proper amount for the rate setting. A ½" drive ratchet supplied in the toolbox is used to adjust the meter shut off slide.

Any time that a new rate is set, the rate setting should be confirmed by calibrating the meter.

A scale and catch bag are supplied in the tool box for calibration.

Once a rate setting is determined from the rate charts and the meter is set to that setting, perform the following calibration procedures.

**When using both tanks for one product,** determine the rate for each meter by splitting the desired rate by the ratio of the tanks (60/40). This will result in both tanks emptying at the same time.

---

### Example

If you desire to seed 120 lbs. of wheat using both meters, split the desired **pounds per acre** rate to the ratio of the size of the tanks. i.e. If the Air System is a 60/40 split, set one meter to 72 lbs. (120 x.6) and the other meter to 48 lbs. (120 x.4)

---

### Note

When decreasing the meter setting, it may be necessary to close the shutoff slide and turn the meter to empty it. This will empty the meter and allow the plate to move to a smaller setting.

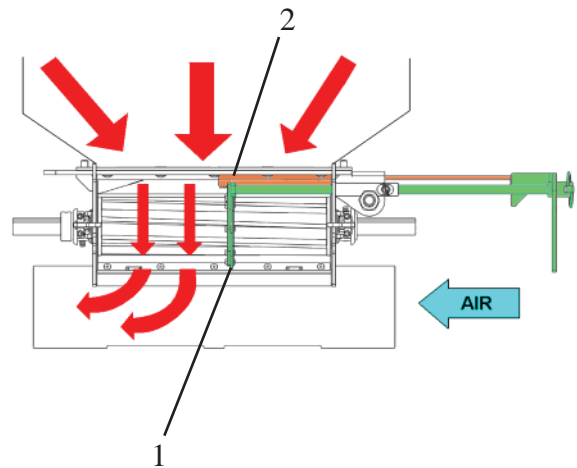
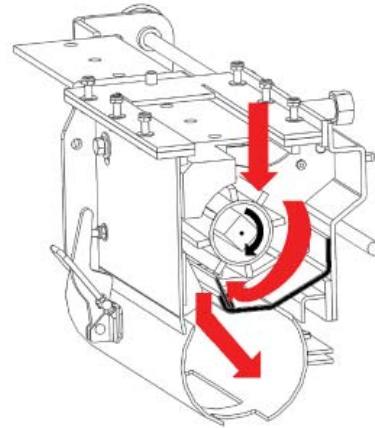

---

### Note

Plate (1) controls how much of meter roller will be used. The shut off slide (2) is opened to the stop on the pointer for any rate setting. When making large rate reductions, close the slide and empty the meter to allow the plate to move to the lower setting. Remember to reopen the slide until it contacts the stop on the pointer.

## Ground Drive (GD) Calibration and Operation

If you have a ground drive (GD) system, calibration involves deciding on a fixed target application rate (lbs/acre) and then setting up the meter mechanically to deliver that rate. The ground drive system compensates for speed changes by varying the meter speed to keep application rate uniform. The calibration procedure also includes entering several pieces of information into the D3 System to ensure accurate indications and to avoid nuisance alarms.

### *Setting up the Application Rate on a GD System*

#### **To set up and operate the ground drive:**

1. Determine your desired target application rate.
2. Set the pointer on the product meter to your desired target rate setting.
3. Secure the setting by tightening the bolt to lock the pointer rod.
4. Use the ratchet supplied to open the shut off slide until it contacts the stop on the pointer.
5. Hang the calibration bag on the scale and zero the scale so the weight of the bag will not compromise the accuracy of the measurement.
6. Open the clean out door under the air tube by releasing the toggle clamps.
7. Turn the crank at the front of the Air System one complete revolution to prime the meter.
8. Hang the calibration bag on the meter tube so that the clean out door is inside of the bag and the bag is under the openings in the bottom of the air tube.
9. Using the table on the right side of this page, determine the number of turns required to cover 1/10 of an acre.
10. Manually crank the meter the required number of turns.
11. Remove the bag and weigh it on the scale. Multiply the weight times 10 to get the rate per acre.
12. Adjust the meter to a higher or lower setting and repeat the procedure until the desired rate is set.

#### ***Seed Rate Setting Tips***

- *When setting a rate for a small amount per acre such as canola or sunflowers, calibrate with more than 1/10 of an acre amount of turns. Turn out a complete acre for rates less than a 10 lb. rate*
- *Recalibrate rates after seeding a partial tank.*
- *Remember to “prime the meter” by turning the crank before calibrating.*
- *Remember to zero the scale with the empty bag on it before calibrating.*
- *Close meter shut off slide on compartment not being calibrated.*

#### ***Note***

*Look up the rate setting for each tank separately in the appropriate rate chart.*

<b>Implement Width ft (m)</b>	<b>Turns (of crank) per Acre (Ha) 10T &amp; 23.1R26</b>	<b>Turns (of crank) per acre (Ha) 15T&amp;23.1R26 17T&amp;18.4R26</b>
30 (9.1)	189 (467)	126 (311)
32 (9.8)	179 (441)	119 (294)
34 (10.4)	168 (415)	112 (277)
36 (11.0)	159 (393)	106 (262)
38 (11.6)	150 (371)	100 (247)
40 (12.2)	143 (352)	95 (235)
42 (12.8)	135 (334)	90 (222)
44 (13.4)	129 (319)	86 (213)
45 (13.7)	128 (315)	85 (210)
46 (14.0)	125 (308)	83 (205)
48 (14.6)	119 (293)	79 (195)
50 (15.2)	114 (282)	76 (188)
52 (15.8)	110 (271)	73 (180)
54 (16.5)	105 (259)	70 (173)
56 (17.1)	102 (252)	68 (168)
58 (17.7)	99 (245)	66 (163)
60 (18.3)	95 (234)	63 (156)

## *Ground Drive Bin Count Monitoring*

---

Ground Drive Bin Count Monitoring allows the operator to utilize the “Bin Count” feature and the product accumulation counter. To set up the system, calculate the “Meter Cal” value for each bin when you calibrate by dividing your sample weight (lb) by the number of times the crank was turned. Set this value for each bin. You also need to set the “Target Rate” based on the target rate value used for calibration.

For example, if you want to apply 60 lbs/acre from Bin 1 and you were able to adjust your meter to get 6 lb from 9.5 turns, set the Meter Cal Value for Bin 1 to 0.63 lb/rev and set the Target Rate to 60 lbs/acre.

$$\text{Meter Cal Value (lb/rev)} = \frac{\text{WeightInBag(lb)}}{\text{TurnsOfTheCrank(rev)}}$$



# Hydraulic Drive Calibration and Operation

Calibration is done in four parts. First, you must prepare the system for calibration. Second, you prime the meter. Third, you take a sample and weigh it. Finally, you enter the sample, or Accumulated weight into the virtual terminal.

## Preparing to Calibrate the Meter

Hydraulic power is needed for calibration. The following procedure sets up the air system for the calibration procedure.

1. Ensure that the air system's hydraulic lines are connected to a tractor.
2. Verify that the tractor hydraulic remote for the blower is in neutral until hydraulic power is needed.
3. Ensure that the monitor wire harness is properly connected to the tractor.
4. Power up the monitor in the tractor.
5. Verify that the VT in the cab is communicating with the Air System ECU.
6. Ensure that the meter door is properly attached to the meter.
7. Ensure the bin is at least 25% full of the product that will be applied.
8. Set the meter gate to the appropriate position for the rate being applied.
9. Ensure the auger selector valve is directing oil to the fan/meter circuit.
10. Close the blower ball-valve.
11. Actuate the tractor remote controlling the blower circuit.
12. Make sure the blower is not spinning for the following steps. If the blower is spinning, check the ball valve to make sure that it is full closed and blocking all flow to the blower..
13. Open the cleanout door below the meter you wish to calibrate.

***The meter must be calibrated if:***

- *The gate setting has been changed*
- *A different product is being used*
- *A different meter roll is being used*

*Each meter must be calibrated individually, even if all the gates are set the same.*



*The Auger Selector Valve*



*Adjusting the Meter Gate*

<b>Meter Gate Setting Guide – Hydraulic Drive - High Capacity Meter Roll</b>				
<b>Rate lbs/ac</b> <i>(kg/Ha)</i>	<b>30 ft</b> <i>(9m)</i>	<b>40 ft</b> <i>(12m)</i>	<b>50 ft</b> <i>(15m)</i>	<b>60 ft</b> <i>(18m)</i>
<b>50</b> <i>(56)</i>	<b>3"</b> <i>(76 mm)</i>	<b>4"</b> <i>(102 mm)</i>	<b>5"</b> <i>(127 mm)</i>	<b>6"</b> <i>(152 mm)</i>
<b>100</b> <i>(112)</i>	<b>4"</b> <i>(102 mm)</i>	<b>6"</b> <i>(152 mm)</i>	<b>8"</b> <i>(203 mm)</i>	<b>10"</b> <i>(254 mm)</i>
<b>150</b> <i>(168)</i>	<b>6"</b> <i>(152 mm)</i>	<b>8"</b> <i>(203 mm)</i>	<b>10"</b> <i>(254 mm)</i>	<b>Max</b>
<b>200</b> <i>(224)</i>	<b>8"</b> <i>(203 mm)</i>	<b>10"</b> <i>(254 mm)</i>	<b>Max</b>	<b>Max</b>

## Priming the Meter

---

To ensure accurate calibration, the meter must be primed with product.

1. On the ECU keypad, locate the button with the number corresponding to the meter you are calibrating. This is called the ECU Calibration button.
2. Press the ECU Calibration button once.  
The meter roll begins spinning.
3. Allow the meter to spin 2 to 3 revolutions to ensure that the meter is full of product.
4. Press the same button again to stop the meter.  
The meter is now primed.

---

### Note

*Each time the calibration button on the ECU is pressed to activate the meter the ECU counts the revolutions of the meter roll. This count is reset each time this process is performed. Once you stop the meter roll, the bag must be weighed. If you did not collect enough product in the bag to obtain a measurable weight, you must dump the bag and start over with an empty bag.*



---

### Note

*To calibrate a product meter it must be enabled (active) on its Product page (1).*

## Taking a Sample for Calibration

---

1. Using the weigh scale included with your system, hang the calibration bag (also included) on the scale and zero out the weight of the bag.
2. Place the calibration bag below the cleanout opening.  
Be careful to ensure all product will flow into the bag.
3. Press the ECU Calibrate button to activate the meter.
4. Allow the meter to spin until the bag is at least half full.
5. Press the ECU Calibrate button again to stop the meter.
6. Weigh the bag with the supplied scale.
7. This value is the Accumulated Weight value you will enter into the VT in lbs (kg).

---

### Note

*Do not press the ECU Calibrate button again until the Accumulated weight is entered into the VT. Pressing the ECU Calibrate button before the weight is entered will clear the rotation counter and void the sample.*

8. Repeat the previous steps to obtain sample weights for the rest of the meters.
9. When all the weights have been found, go back to the tractor and enter the calibration weights into the Product page on the Virtual Terminal.



## Entering Accumulated Weight into the Monitor

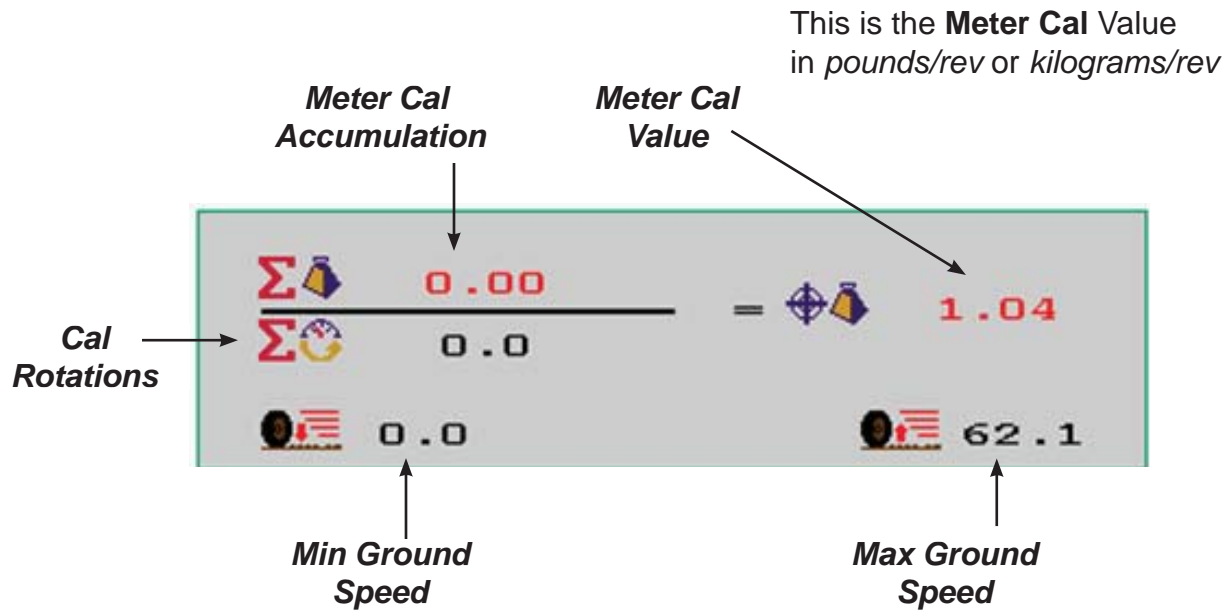

### About Meter Cal

Once you enter the **Accum** (lb) value (in Step 3) the ECU automatically calculates the **Meter Cal** value. The **Meter Cal** value is the number of pounds (lb) of product applied per revolution of the meter roller.

E.g. If the **Meter Cal** value is 1.50, the meter will deliver 1.50 lb of material during each revolution of the meter roll.

Step 1. With an accumulated weight value, return to the virtual terminal monitor.

Step 2. On the Main (Home) page  , press the soft key for the desired product.

The Product page for the selected product appears.

Step 3. On the Product page, select the number next to **Meter Cal Accumulation**. 

Step 4. Enter the accumulated weight value obtained in previous meter calibration procedure in pounds (kilograms).

Step 5. Press Home soft key to return to the Main (Home) page.

**Repeat Steps for each additional bin.**

THIS PAGE  
INTENSIONALLY  
LEFT BLANK

# WHEAT

High Capacity Flute P/N 65705  
1/4" WIDE X 1/2" DEEP BARS

GROUND DRIVE ONLY  
17T GEAR BOX SPROCKET W/ 18.4 R26 TIRES  
15T GEAR BOX SPROCKET W/ 23.1 R26 TIRES

WIDTH (FT)	APPLICATION RATE (LBS PER ACRE)																		
	60	70	80	90	100	110	120	130	140	150	160	170	180	190	200	210	220	230	240
20	2.7	3.1	3.6	4.0	4.5	5.0	5.4	5.8	6.3	6.7	7.2	7.6	8.1	8.5	8.9	9.4	9.8	10.3	10.8
25	3.4	3.9	4.5	5.0	5.6	6.2	6.8	7.3	7.8	8.4	8.9	9.5	10.1	10.6	11.2	11.8	12.3	12.9	13.4
30	4.1	4.7	5.4	6.0	6.8	7.4	8.1	8.8	9.4	10.1	10.7	11.4	12.1	12.8	13.4				
35	4.7	5.5	6.3	7.0	7.9	8.7	9.5	10.2	10.9	11.7	12.5	13.3							
40	5.4	6.3	7.2	8.0	9.0	9.9	10.8	11.7	12.5	13.4									
45	6.1	7.1	8.1	9.0	10.1	11.1	12.2	13.2											
50	6.8	7.9	9.0	10.0	11.3	12.4	13.5												
55	7.4	8.7	9.9	11.0	12.4	13.6													
60	8.1	9.4	10.8	12.0	13.5														

APPROXIMATE POINTER SETTING

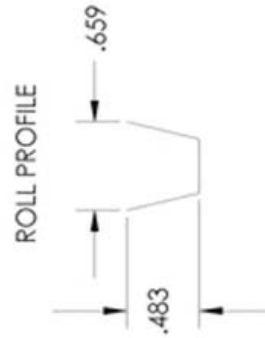
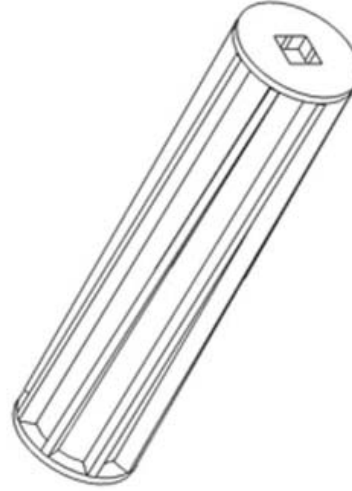



# FERTILIZER (60 LBS PER CUBIC FT.)

High Capacity Flute P/N 65705  
1/4" WIDE X 1/2" DEEP BARS

GROUND DRIVE ONLY  
17T GEAR BOX SPROCKET W/ 18.4 R26 TIRES  
15T GEAR BOX SPROCKET W/ 23.1 R26 TIRES

WIDTH (FT)	APPLICATION RATE (LBS PER ACRE)																		
	60	70	80	90	100	110	120	130	140	150	160	170	180	190	200	210	220	230	240
20	2.3	2.7	3.1	3.5	3.8	4.2	4.6	5.0	5.4	5.8	6.1	6.5	6.9	7.3	7.7	8.1	8.4	8.8	9.2
25	2.9	3.4	3.8	4.3	4.8	5.3	5.8	6.2	6.7	7.2	7.7	8.2	8.6	9.1	9.6	10.1	10.6	11.0	11.5
30	3.5	4.0	4.6	5.2	5.8	6.3	6.9	7.5	8.1	8.6	9.2	9.8	10.4	10.9	11.5	12.1	12.7	13.2	13.8
35	4.0	4.7	5.4	6.0	6.7	7.4	8.1	8.7	9.4	10.1	10.8	11.4	12.1	12.8	13.4				
40	4.6	5.4	6.1	6.9	7.7	8.4	9.2	10.0	10.8	11.5	12.3	13.1	13.8						
45	5.2	6.0	6.9	7.8	8.6	9.5	10.4	11.2	12.1	13.0	13.8								
50	5.8	6.7	7.7	8.6	9.6	10.6	11.5	12.5	13.4										
55	6.3	7.4	8.4	9.5	10.6	11.6	12.7	13.7											
60	6.9	8.1	9.2	10.4	11.5	12.7	13.8												

APPROXIMATE POINTER SETTING

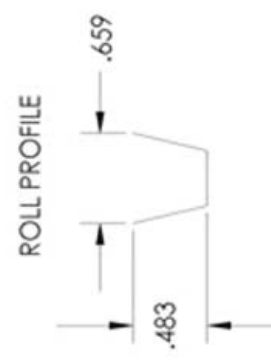
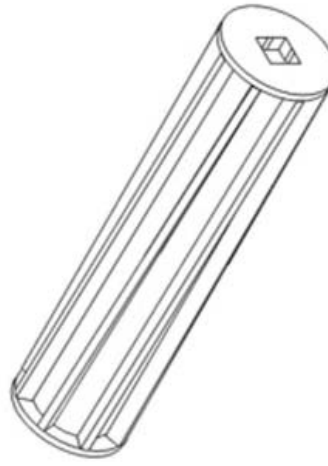

# SOYBEANS

High Capacity Flute PIN 65705  
1/4" WIDE X 1/2" DEEP BARS

GROUND DRIVE ONLY  
17T GEAR BOX SPROCKET W/ 18.4 R26 TIRES  
15T GEAR BOX SPROCKET W/ 23.1 R26 TIRES

WIDTH (FT)	APPLICATION RATE (LBS PER ACRE)																		
	60	70	80	90	100	110	120	130	140	150	160	170	180	190	200	210	220	230	240
20	3.1	3.6	4.1	4.6	5.2	5.7	6.2	6.7	7.2	7.7	8.2	8.8	9.3	9.8	10.4	10.9	11.4	11.9	12.4
25	3.9	4.5	5.2	5.8	6.4	7.1	7.8	8.4	9.0	9.6	10.3	10.9	11.6	12.2	12.9	13.6			
30	4.7	5.4	6.2	6.9	7.7	8.6	9.3	10.1	10.8	11.6	12.3	13.1	13.9						
35	5.4	6.3	7.2	8.0	9.0	10.0	10.9	11.7	12.6	13.5									
40	6.2	7.2	8.3	9.2	10.3	11.4	12.4	13.4											
45	7.0	8.1	9.3	10.4	11.6	12.8	14.0												
50	7.8	9.1	10.3	11.5	12.9	14.0													
55	8.5	10.0	11.4	12.6	14.2														
60	9.3	10.9	12.4	13.8															

APPROXIMATE POINTER SETTING

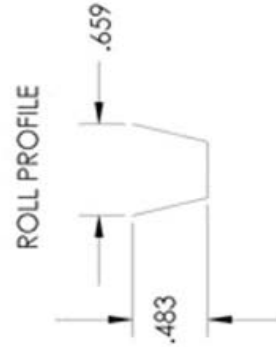
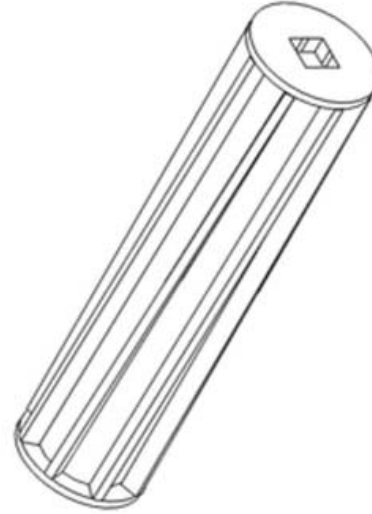

# BARLEY

High Capacity Flute P/N 65705  
1/4" WIDE X 1/2" DEEP BARS

GROUND DRIVE ONLY  
17T GEAR BOX SPROCKET W/ 18.4 R26 TIRES  
15T GEAR BOX SPROCKET W/ 23.1 R26 TIRES

		APPLICATION RATE (LBS PER ACRE)																		
		60	70	80	90	100	110	120	130	140	150	160	170	180	190	200	210	220	230	240
WIDTH (FT)	20	3.4	3.9	4.5	5.0	5.6	6.2	6.7	7.3	7.8	8.4	8.9	9.5	10.1	10.7	11.2	11.8	12.3	12.9	13.4
	25	4.2	4.9	5.6	6.3	7.0	7.7	8.4	9.1	9.8	10.5	11.2	11.9	12.6	13.3					
	30	5	5.8	6.7	7.6	8.4	9.2	10.1	10.9	11.8	12.6	13.4								
	35	5.9	6.8	7.8	8.8	9.8	10.8	11.7	12.8	13.7										
	40	6.7	7.8	8.9	10.1	11.2	12.3	13.4												
	45	7.5	7.0	10.0	11.4	12.6	13.8													
	50	8.4	9.8	11.1	12.6	14.0														
	55	9.2	10.7	12.2	13.9															
	60	10.1	11.7	13.4																

APPROXIMATE POINTER SETTING

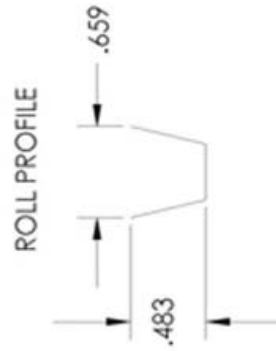
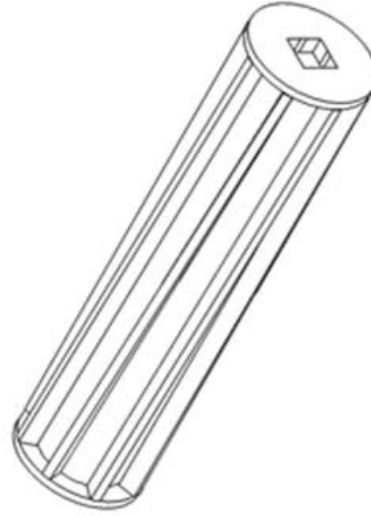



# CANOLA

FINE PRODUCT METER ROLL P/N 67639  
1/2" WIDE X 1/8" DEEP SLOTS

GROUND DRIVE ONLY  
17T GEAR BOX SPROCKET W/ 18.4 R26 TIRES  
15T GEAR BOX SPROCKET W/ 23.1 R26 TIRES

WIDTH (FT)	3	4	5	6	7	8	9	10	11	12	13	14	15
20						0.8	1.4	2.1	2.8	3.5	4.2	4.9	5.6
25			0.4	1.3	2.1	3	3.9	4.7	5.6	6.4	7.3	8.2	
30		0.4	1.4	2.5	3.5	4.5	5.6	6.6	7.6	8.7	9.7	10.7	
35		1.3	2.5	3.7	4.9	6.2	7.3	8.5	9.7	10.9	12.1	13.3	
40	0.8	2.1	3.5	4.9	6.3	7.6	9	10.4	11.8	13.1			
45	1.4	3	4.5	6.1	7.6	9.2	10.7	12.3					
50	0.4	2.1	3.9	5.6	7.3	9	10.7	12.5					
55	0.9	2.8	4.7	6.6	8.5	10.4	12.3						
60	1.4	3.5	5.6	7.6	9.7	11.8							

APPROXIMATE POINTER SETTING

ROLL PROFILE

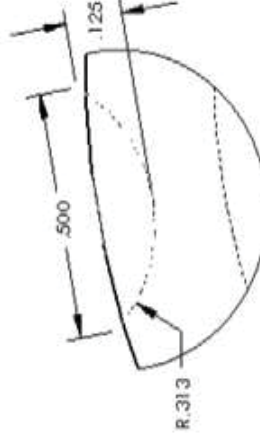

DETAIL A  
SCALE 4 : 1

NOTE:

1. ALL SLOTS ARE .125" DEEP
2. ALL SLOTS ARE 1.00" LONG
3. 1.50 SLOT OFFSET WITHIN ROWS



# MECHANICAL SYSTEMS - MAINTENANCE AND TROUBLESHOOTING

## Routine Maintenance

---

### *Drive Line and Steering*

---

Lubricate all drive line bearings and steering components every 50 hours with a SAE multipurpose grease.

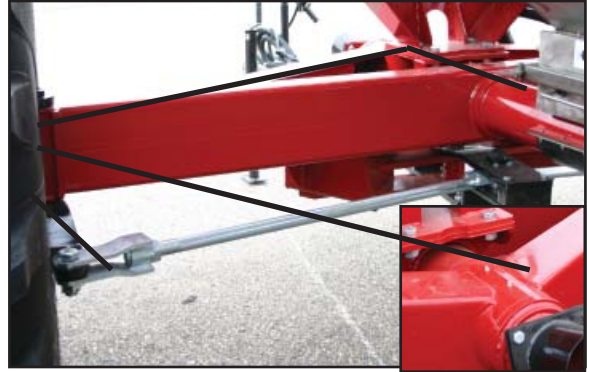

### *Gear Box*

---

The gear box is filled at the factory and requires no maintenance. Service is required only if oil leaks become visible.



### *Hydraulic Motor*

---

The hydraulic motor can only be damaged by heat or foreign material. Keep your tractor hydraulic oil and filter serviced regularly to ensure long life from your hydraulic components.



### *Wheel Bearings*

---

Annually check wheel bearings for tightness. Adjust if needed. Repack every three (3) years.



## Changing Metering Rolls - Ground Drive System

### To change metering rolls on a GD System:

1. Close the meter gate or ensure the bin is empty.
2. Remove the meter door and set aside.
3. Remove the chain from the meter drive sprocket. Do not remove the sprocket.
4. Remove the two nuts that hold the bearing on the meter shaft (sprocket end only).
5. Pull the shaft out of the meter while holding on to the meter roll.
6. Remove the meter roll.
7. Re-assemble the meter in reverse order with the desired flute.

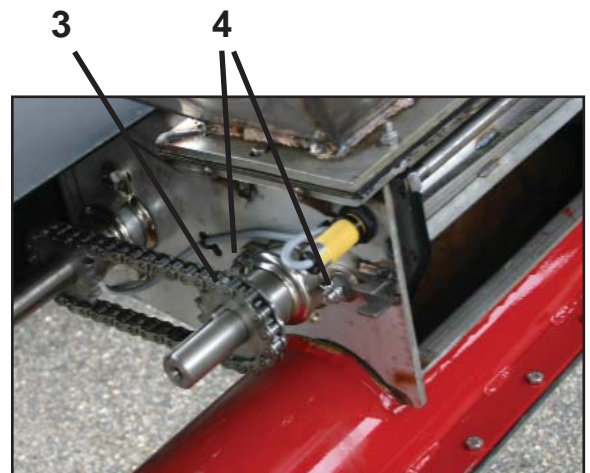

## Changing Metering Rolls - Hydraulic System

---

### To change metering rolls on a Hydraulic System:

1. Close the meter gate or ensure the bin is empty.
2. Remove the meter door and set aside.
3. Remove the (2) ½" bolts holding the hydraulic motor to the motor mount.
4. Remove the two nuts that hold the bearing on the meter shaft (motor-end only).
5. Pull the shaft out of the meter (with the motor still attached) while holding on to the meter roll.
6. Remove the meter roll.
7. Re-assemble the meter in reverse order with the desired meter roll.



## Meter Roll Options

---

Amity's standard high capacity and optional medium capacity meter rollers are constructed of stainless steel for lifetime performance

Four meter roll options are available.

The high capacity roll has eight ½" deep bars and is used for most applications.

The medium capacity roll has twelve ¼" deep bars and is used on smaller machines or for consistently lower seeding or fertilizer rates.

The low volume has a pattern of short, shallow depressions to gradually larger, deeper depressions for very low seeding rate.

The fine product meter roll has a continuous pattern of shallow depressions for very low seeding rates with high accuracy.

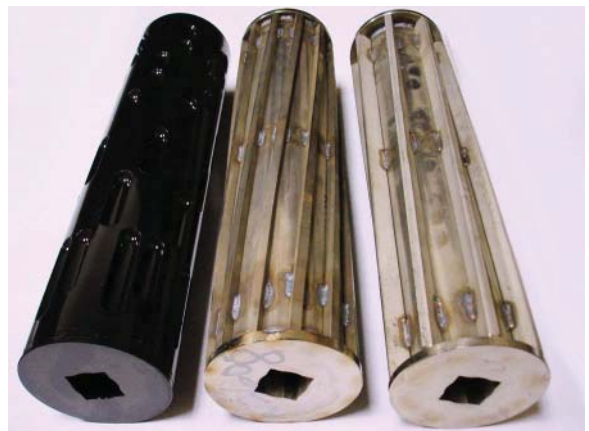



## Other Meter Adjustments

---

The following adjustments are done at the factory and should only be done by a trained service technician.

### *Shims*

---

- The meter roll should have a small gap (.030") between the roll and the meter housing for proper operation. If the gap is too large product can leak around the meter roll into the air stream. If the gap is too tight the meter roll will bind on the housing and cause problems with the meter drive system.
- A .030" thick shim (Amity P/N 65744) can be installed between the meter roll and the meter housing to reduce this gap. The meter shaft needs to be removed to install this shim, see the section on changing meter rolls on the procedure to remove the shaft.
- Ensure the meter roll turns freely after installing or removing any shims. If the meter roll does not turn freely, DO NOT operate the air system until enough shims have been removed to allow the meter roll to turn freely.

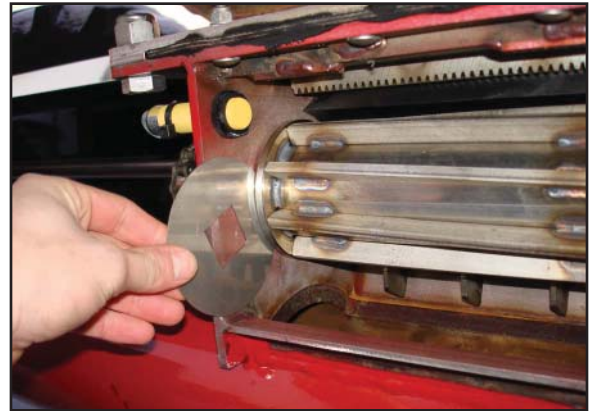

### *Deflector Block*

---

The black plastic deflector block in the rear of the meter prevents seed from flowing around the back side of the meter roll. If needed, this block can be adjusted vertically to increase or decrease the clearance to the meter roll. To adjust, loosen the two nuts on the back side of the meter housing, move the block to the desired position, and tighten the nuts to lock the block into place.

### *Meter Door and Cleanout Door Latches*

---

The tension on these latches can be adjusted to increase or decrease the preload on the meter door and the cleanout door. If the preload is too small, the doors will not seal properly. If the tension is too tight, the latches will be difficult to close. The tension can be adjusted by unlocking the latch and screwing the two stop-nuts evenly in or out. Ensure the door preload is adequate before putting the unit back into service.



### *Meter Door Tray*

---

The tray on the meter door can be adjusted vertically in order to increase or decrease the tension between the rubber seal on the tray and the meter roll. To adjust, loosen the two nuts holding the tray to the meter door, move the tray to the desired position, and tighten the nuts to lock the tray into place.



## Gear Box

The gear box is filled with oil at the factory and does not require service. If a visible leak appears at one of the seals, repair the box and fill half-full with 85W90 oil (Amity P/N: 330132).

The drive line components are protected by a shear pin located on the gearbox coupler. If the pin fails, determine the reason for the failure, remove, and install a new shear pin.

### To replace the shear pin:

1. Loosen the bolt on the locking tab and rotate the tab out of the machined groove in the shear pin.
2. Remove any broken shear pin pieces and line up the holes in the coupler with the hole in the shaft.
3. Install a new shear pin.
4. Rotate the lock tab into the machined groove on the shear pin and tighten the bolt on the tab.



*Gear box*



*Gear box shear pin*

## Mechanical Systems Troubleshooting: Common Problems and Solutions

Symptom	What it means	Recommended Action
Seed cups will not engage	Shear pin may have broken	Clear obstruction and replace pin.
	Clutch has no power going to it	Be sure there is power to clutch using test light.
	Clutch may have failed	Replace clutch.
Seed cups will not disengage	Sprocket on clutch may have frozen shaft	Check plastic bearing under sprocket.
	Short in monitor is supplying power to the clutch.	Find short and repair.
Seed is flowing without cups turning. (A small amount of seed flow is normal and not a cause for concern.)	Rubber deflector is not down tightly on flute.	Lower the deflector.
	Rubber wiper on seed cup door damaged or not up tightly against flute.	Raise door or replace rubber wiper if damaged.
	Product is building up in air delivery system.	Increase blower speed.
Excessive seed cracking is occurring	Air stream velocity is too great.	Reduce blower speed or adjust blower baffle on dual air stream machines.
Seed boots are plugging	Turning corners too sharply with boots in the ground.	Always raise ground opener before making a sharp turn.
	Ground openers have been left in the ground when backing up.	Always raise ground opener before backing up.
Product distribution is uneven	A one inch hose may be plugged.	Re-route or cut 1" hoses to eliminate sags. Clear any obstruction in hoses or boots.
Uneven delivery rate	Loss of tank pressure.	Check tank lids for leaks. Inspect and replace faulty gaskets.
Oil showing up on seed lines	Shaft seal failure on hydraulic motor.	Replace seal. <b>WARNING: DO NOT DISASSEMBLE HYDRAULIC MOTOR!! THE SHAFT SEAL IS AN EXTERNAL REPLACEMENT ITEM.</b>
Hydraulic motor slow	Monitor set to wrong blower speed setting ( See Monitor Section).	See Monitor Section
	Tractor is not putting out adequate oil.	Have tractor dealer inspect tractor hydraulics.
	Bad couplers.	Check couplers on tractor and hoses. Try different couplers.

## Storage

---

- Fully open the seed meters.
- Open clean out doors on the bottom of the air tube.
- Clean any remaining product from tanks.
- Use water to thoroughly clean any compartment used for fertilizer
- Thoroughly clean fertilizer and dirt from cup area.
- Clean the inside of the seed meter door. Fertilizer, seed and dirt accumulate in this area.
- Clean any remaining product from the auger and leave the auger slide open.
- Oil chains.
- Grease all lubrication points.
- Check the gear box for visible leaks. If none, no service is required.
- Release the latch on the tank lids to relieve pressure on the lid gaskets.





# APPENDIX: CONNECTOR PINOUTS

## ECU Signal Connectors



<i>Left Connector (Black Body)</i>		<i>Center Connector (Grey Body)</i>	<i>Right Connector (Blue Body)</i>		
<i>Pin #</i>	<i>Function</i>	<i>Pin #</i>		<i>Pin #</i>	<i>Function</i>
1	Motor 1 Power	1		1	Bin 3 Signal
2	Motor 4 Power	2		2	Meter 3 Signal
3	CAN Comm. High	3		3	
4	Bin 1 Signal	4		4	
5	Meter Box 1 Signal	5		5	
6		6		6	
7	Meter Box 2 Signal	7		7	
8	Motor 1 Ground	8		8	
9	Bin 2 Signal	9		9	
10	Motor 3 Ground	10	Sensor Power (12V)	10	
11	Speed Signal	11		11	
12	Motor 3 Power	12		12	
13	Fan 1 Signal	13		13	
14	Fan 2 Signal	14		14	
15	CAN Comm. Low	15		15	
16		16		16	
17	Tach 1 Ground	17		17	
18	Tach 2 Ground	18		18	
19	Tach 3 Ground	19		19	
20	Tach 2 Signal	20		20	
21	Tach 4 Ground	21	Sensor Ground	21	
22	ECU Ground	22		22	
23	ECU Power	23		23	
24	Tach 1 Signal	24		24	
25	Motor 2 Ground	25		25	
26	Motor 2 Power	26		26	
27	Tach 4 Signal	27		27	
28	Tach 1 Power	28		28	
29	Tach 2 Power	29		29	
30	Tach 3 Power	30		30	Bin 4 Signal
31	Tach 4 Power	31		31	
32	Work Signal	32		32	Meter 4 Signal
33	Motor 4 Ground	33		33	
34	Tach 3 Signal	34		34	
35		35		35	

## ISO-BUS Connector

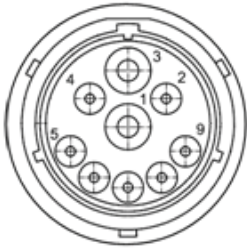

Pin #	Function
1	Battery Negative
2	ECU Ground
3	Battery Positive
4	ECU Power
5	TBC_DIS
6	TBC_PWR
7	TBC_RTN
8	CAN H
9	CAN L

### Note:

- Battery Positive and Negative on double 8AWG wiring to reduce voltage drop between battery and ECU power terminals in high current systems.
- Dust cap provided to protect connector when not in use

## CAN Terminator Connector



Pin #	Function
A	
B	TBC PWR
C	
D	TBC RTN
E	CAN H
F	CAN L

### Note:

- Connector mates with Powell TBC. TBC (CAN BUS terminating bias circuit) should only be installed at the physical end of the CANBUS system.
- Terminated in Metripack 12052848 connector (150 Series)

## ECU Power Contacts



Pin #	Function
N/A	Battery Positive (red)
N/A	Battery Negative (black)

### Note:

- #10 (M5) ring terminal connects to ECU power terminals.
- Battery Positive and Negative on double 8AWG wiring to reduce voltage drop between battery and ECU power terminals in high current systems.
- Caution! – reverse polarity power connection will damage ECU

## Motor Control Connectors



Pin #	Function
1	Motor Power
2	Motor Ground

### Note:

- Electric motor or electric over hydraulic control is possible
- Terminated in Deutsch DT06-2S connector, contacts rated to 13 amps, 16AWG wiring
- Mating connector is Deutsch DT04-2P

## Motor Speed (Tach) Connectors



Pin #	Function
1	Tach Power
2	Tach Signal
3	Tach Ground

### Note:

- Connector mates with Powell TBC. TBC (CAN BUS terminating bias circuit) should only be installed at the physical end of the CANBUS system.
- Terminated in Metripack 12052848 connector (150 Series)

## Low-Bin Level Sensor Connectors



Pin #	Function
1	Bin Power
2	Bin Signal
3	Bin Ground

### Note:

- Independent feedback for up to 4 bin level sensors (infrared, capacitive proximity)
- Mates directly to Agtron bin level sensors, 3rd party sensors may require additional wiring
- Terminated in Deutsch DTM06-3S connector, contacts rated to 7 amps, 20AWG wiring
- Mating connector is Deutsch DTM04-3P

## Meter Box Sensor Connectors



Pin #	Function
1	Meter Power
2	Meter Signal
3	Meter Ground

### Note:

- Independent feedback for up to 4 additional bin level sensors (infrared, capacitive proximity)
- Mates directly to Agtron bin level sensors, 3rd party sensors may require additional wiring
- Terminated in Deutsch DTM06-3S connector, contacts rated to 7 amps, 20AWG wiring
- Mating connector is Deutsch DTM04-3P

## Ground Speed Sensor Connectors



<b>Pin #</b>	<b>Function</b>
1	Speed Power
2	Speed Signal
3	Speed Ground

### **Note:**

- *Ground speed sensor feedback (hall effect, reed switch, inductive)*
- *Mates directly to Agtron inductive and reed switch sensors, 3rd party sensors may require additional wiring*
- *Wiring is common between the radar and speed sensor connections; only one speed source can be used.*
- *Terminated in Deutsch DTM06-3S connector, contacts rated to 7 amps, 20AWG wiring*
- *Mating connector is Deutsch DTM04-3P*

## Fan Sensor Connectors



<b>Pin #</b>	<b>Function</b>
1	Fan Power
2	Fan Signal
3	Fan Ground

### **Note:**

- *Independent feedback for up to 2 fan RPM sensors (hall effect, reed switch, inductive)*
- *Mates directly to Agtron inductive and reed switch sensors, 3rd party sensors may require additional wiring*
- *Terminated in Deutsch DTM06-3S connector, contacts rated to 7 amps, 20AWG wiring*
- *Mating connector is Deutsch DTM04-3P*

## Anhydrous Ammonia/Liquid Control Connector



<b>Pin #</b>	<b>Function</b>
A	Flowmeter Signal
B	Battery Positive
C	Flowmeter Ground
D	N/A
E	Flowmeter Power
F	Shutoff Valve Ground
G	Rate Control Valve Negative
H	Rate Control Valve Positive
J	Shutoff Valve Power
K	Battery Negative

**Note:**

- Terminated in Metripack 150 series 10 pin receptacle
- Mates directly to Micro-Trak harness part number 13273.
- Adaptors for the Raven Accu-Flow system available.

# Approximate Tank Fill Percentages

Approximate Tank Fill Percentages					
Ladder Rung (from top)	Model 2800	Model 3350	Model 5250		
	Front & Rear	Front & Rear	Front	Middle	Rear
1st	90%	85%	99%	99%	99%
2nd	75%	60%	85%	90%	85%
3rd	45%	35%	65%	65%	65%
4th	15%	15%	45%	40%	45%
5th	5%	5%	20%	15%	20%
6th	N/A	N/A	5%	5%	5%

# Advanced Screens

	Bin 1	Bin 2	Bin 3	Bin 4	Bin 5	NH3
	1	2	3	4	5	N
Product Enable						
GND/HYD Drive						
Tank Size		175	225	125		1500
Target Rate		0.0	0.0	0.0		0.0
Actual Rate		0.0	0.0	0.0		0.0
Implement Width		480	480	480		480
Minimum RPM		10	10	10		
Maximum RPM		100	100	100		
Calibration RPM		25	25	25		
Target RPM		0	0	0		0
Actual RPM		0	0	0		0
Drive A Current Overload		15.0	15.0	15.0		10.0
Drive B Current Overload						7.5
Drive Gain		50	50	50		50
Tach Targets/Rev		60	60	60		
Allowable Error %		10	10	10		20
Fixed PWM% Output Override		0	0	0		
Drive Direction						
Drive Frequency						100
NH3 Valve Type						2



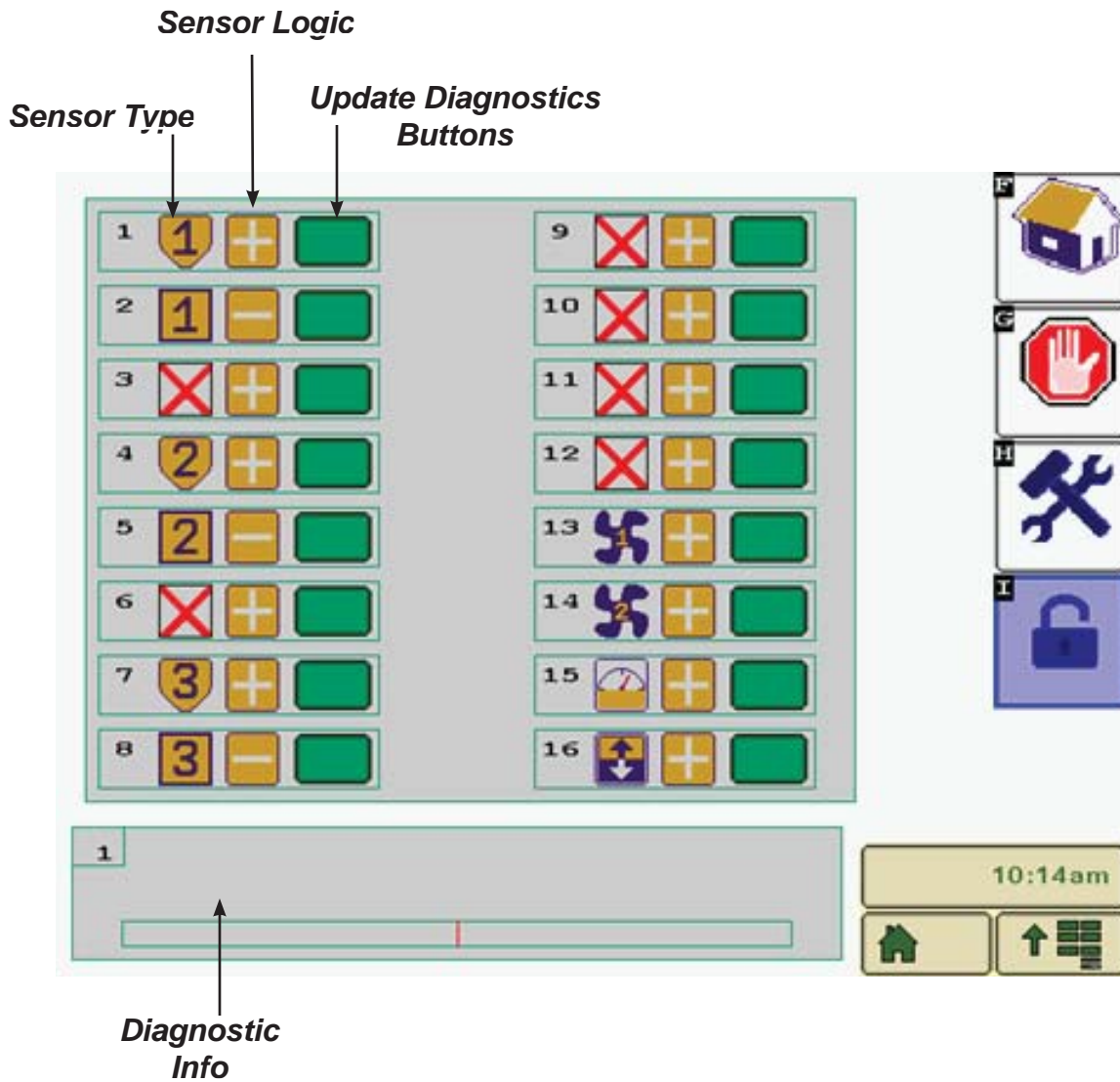







**Cart ECU Sensor Channel Info**

- |                 |                                     |
|-----------------|-------------------------------------|
| 1 – Bin 1       | 9 – N/A                             |
| 2 – Meter Box 1 | 10 – Bin 4                          |
| 3 – N/A         | 11 – Meter Box 4                    |
| 4 – Bin 2       | 12 – N/A                            |
| 5 – Meter Box 2 | 13 – Fan 1                          |
| 6 – N/A         | 14 – Fan 2 (Opt.)                   |
| 7 – Bin 3       | 15 – Ground Speed (ECU Input)       |
| 8 – Meter Box 3 | 16 – External Automatic Work Switch |

## Sensor Types

Symbol	Sensor Type
	Bin 1-4
	Meter Box 1-4
	Fan 1-2
	Ground Speed
	Internal Work Switch
	External Work Switch
	None

